

www.-cerámica.com

Hydromassage catalogue - price list

Catálogo de hidromasaje

Le catalogue des hydromassage

Hydromassage-Katalog

Together, we are stronger

HYDRO COLUMNS/COLONNES HYDRO

FEEL 1300

€ CR € CR

888284 FEEL 1300 W/THERMOSTATIC MIXER ① 260X500X1340 1943.95
COLONNE HYDRO FEEL 1300 A/MITIGEUR THERMOSTATIQUE [19.0Kg] CR. GREEN GLASS | VERRE VERT

888384 WALL MOUNTED FEEL 1300 W/THERMOSTATIC MIXER ② 280X420X1340 1660.42
COLONNE HYDRO FEEL 1300 À ENCASTRER A/MITIGEUR THERMOSTATIQUE [19.0Kg] CR. BLACK GLASS | VERRE NOIR

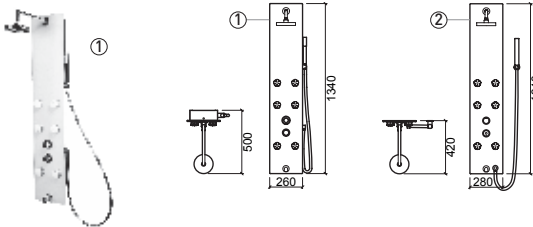

RELAX

€ W/B

8880841 RELAX W/THERMOSTATIC MIXER ① 300X280X1650 926.24
COLONNE HYDRO RELAX A/MITIGEUR THERMOSTATIQUE [11.9Kg] CR. WHITE ACRYLIC ACRYLIQUE BLANC

8880801 RELAX W/SINGLE E-LEVER MIXER ② 300X280X1650 881.41
COLONNE HYDRO RELAX A/MITIGEUR [11.8Kg] CR. WHITE ACRYLIC ACRYLIQUE BLANC

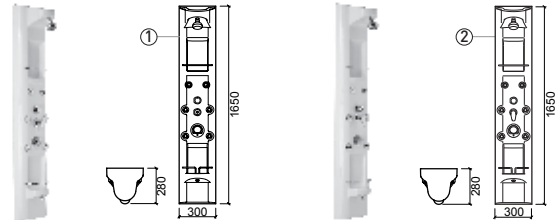

FEEL 1600

€ CR

888184 FEEL 1600 W/THERMOSTATIC MIXER 260X500X1590 2432.56
COLONNE HYDRO FEEL 1600 A/MITIGEUR THERMOSTATIQUE [24.0Kg] CR. GREEN GLASS | VERRE VERT

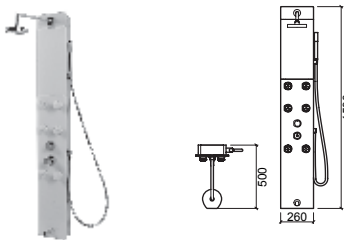

RELAX CORNER/D'ANGLE

€ W/B

8880741 RELAX W/THERMOSTATIC MIXER ① 300X280X1650 1054.72
COLONNE HYDRO RELAX A/MITIGEUR THERMOSTATIQUE [11.9Kg] CR. WHITE ACRYLIC ACRYLIQUE BLANC

8880701 RELAX W/SINGLE E-LEVER MIXER ② 300X280X1650 963.57
COLONNE HYDRO RELAX A/MITIGEUR [11.8Kg] CR. WHITE ACRYLIC ACRYLIQUE BLANC

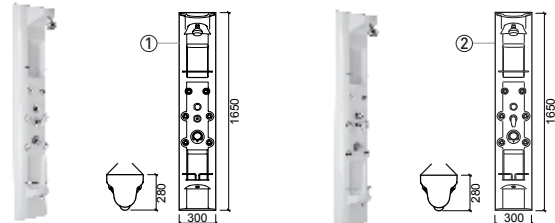

ENJOY

€ W/B

888480 ENJOY F/SHOWER TRAY [-] ① 280X310X1700 904.54
COLONNE HYDRO ENJOY P/RECEVEUR DE DOUCHE [-] [9.5Kg] CR. WHITE ACRYLIC ACRYLIQUE BLANC

888580 ENJOY F/BATHTUB [-] ② 220X310X1480 842.07
COLONNE HYDRO ENJOY P/BAIGNOIRE [-] [8.5Kg] CR. WHITE ACRYLIC ACRYLIQUE BLANC

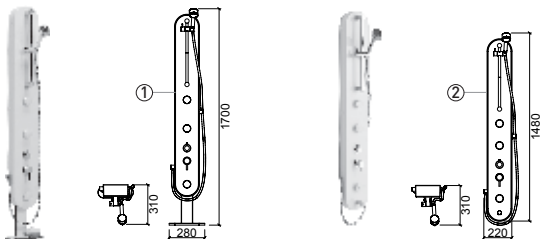

SHADOW

€ W/B

8887841 SHADOW W/THERMOSTATIC MIXER ① 271X372X1410 832.34
COLONNE HYDRO SHADOW A/MITIGEUR THERMOSTATIQUE [11.9Kg] CR. WHITE ACRYLIC ACRYLIQUE BLANC

8887801 SHADOW W/SINGLE E-LEVER MIXER ② 257X372X1410 774.87
COLONNE HYDRO SHADOW A/MITIGEUR [11.8Kg] CR. WHITE ACRYLIC ACRYLIQUE BLANC

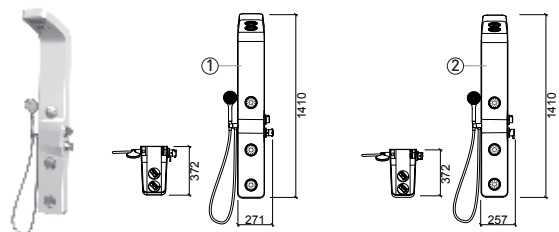

HYDRO CABIN/CABINE HYDRO

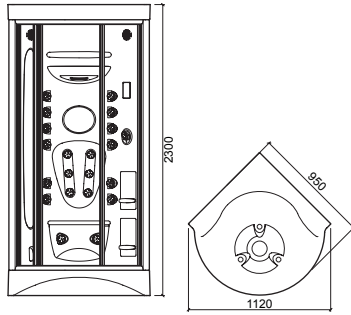

SENSIS

€ W/B

870300	MULTI-SENSIS	1120X950X2300	7539.29
	[117.0Kg]		
870200	EXTRA-SENSIS	1120X950X2300	5713.12
	[110.0Kg]		
870100	BASIC-SENSIS	1120X950X2300	4482.83
	[105.0Kg]		

COLORS OF CUSHIONS: WHITE | GREY | GREEN
COULEURS DE COUSSINS: BLANC | GRIS | VERT

FEATURES | CARACTÉRISTIQUES

● basic Sensis ● extra Sensis ● multi Sensis

- TURKISH BATH | BAIN TURC
- AROMATHERAPY | AROMATHÉRAPIE
- 12 VERTICAL JETS W/3 FUNCTIONS | 12 JETS VERTICAUX 3 FONCTIONS
- 10 VERTICAL JETS W/3 FUNCTIONS | 10 JETS VERTICAUX 3 FONCTIONS
- 4 BACK JETS W/3 FUNCTIONS | 4 JETS DORSAUX 3 FONCTIONS
- 2 CERVICAL JETS W/3 FUNCTIONS | 2 JETS CERVICAUX 3 FONCTIONS
- 2 JETS F/THE CALVES W/3 FUNCTIONS
2 JETS POUR LES JAMBES 3 FONCTIONS
- 3 TOP JETS W/3 FUNCTIONS | 3 JETS DE SOMMET 3 FONCTIONS
- 2 PLANAR JETS | 2 JETS PLATS
- PULSATING JETS | JET À DÉBIT PULSÉ
- LYMPH DRAINAGE | LYMPHODRAINAGE
- SCOTTISH SHOWER | DOUCHE ÉCOSSAISE
- CHROMOTHERAPY | CHROMOTHÉRAPIE
- WATERFALL | CASCADE

- TOP HEAD SHOWER (NOT MOVEABLE) | DOUCHE FIXE DU SOMMET
- HAND SHOWER | DOUCHETTE
- LIGHT | VOYANT
- ELECTRONIC PANEL | TABLEAU ÉLECTRONIQUE
- THERMOSTATIC FAUCET | MITIGEUR THERMOSTATIQUE
- SINGLE FAUCET | MITIGEUR MONO COMMANDE
- RADIO HI-FI CONNECTION | RADIO, CONNEXION HI-FI
- REMOVABLE (W/MAGNETS) CUSHIONS AND BACK REST MADE OF SPONGE | COUSSINS ET APPUIS EN MOUSSE AMOVIBLES À AIMANTS
- MIRROR | MIROIR
- SEAT | BANC
- SHELVES | ETAGÈRES
- CEILING | SOMMET
- SHOWER BASE | BASE DE LA DOUCHE
- SLIDING DOORS | PORTES COULISSANTES

HYDRO SOLUTIONS/SOLUTIONS D'HYDRO

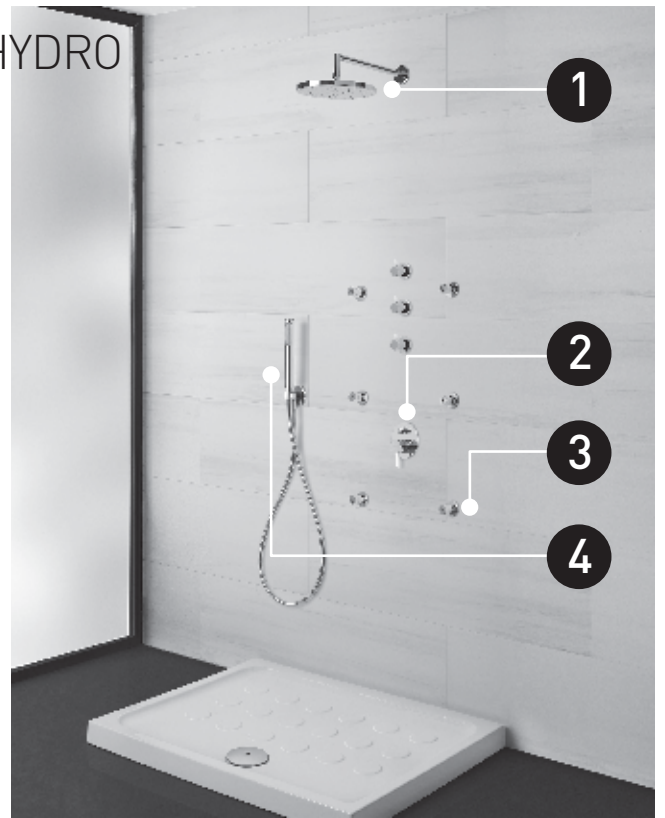

1 FACE 180

€ CHROME

58291	FACE 180 SHOWER HEAD POMMEAU P/DOUCHETTE FACE 180 [0.4Kg]	Ø180X62	84.54
--------------	--	---------	--------------



1 FACE 250

€ CHROME

58691	FACE 250 SHOWER HEAD POMMEAU P/DOUCHETTE FACE 250 [0.9Kg]	Ø248X53	213.99
--------------	--	---------	---------------



1 SQUARE



€ CHROME

55991	SQUARE 200 SHOWER HEAD ① POMMEAU P/DOUCHETTE SQUARE 200 [1.0Kg]	200X200X60	222.94
56091	SQUARE 250 SHOWER HEAD ② POMMEAU P/DOUCHETTE SQUARE 250 [1.5Kg]	250X250X60	257.75
57491	SQUARE 300 SHOWER HEAD ③ POMMEAU P/DOUCHETTE SQUARE 300 [2.8Kg]	299X299X60	327.23
56191	SQUARE 500 SHOWER HEAD ④ POMMEAU P/DOUCHETTE SQUARE 500 [5.2Kg]	500X500X60	699.47

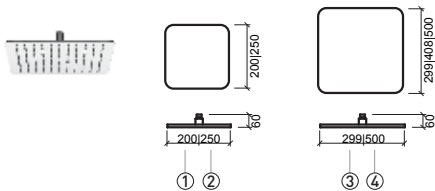

1 EXTRA-LARGE

€ CHROME

58591	EXTRA-LARGE 180 SHOWER HEAD POMMEAU P/DOUCHETTE EXTRA-LARGE 180 [0.4Kg]	Ø180X69	84.54
--------------	--	---------	--------------



1 ÁREA



€ CHROME

56291	ÁREA 200 SHOWER HEAD ① POMMEAU P/DOUCHETTE ÁREA 200 [0.9Kg]	Ø200X60	210.63
56891	ÁREA 250 SHOWER HEAD ② POMMEAU P/DOUCHETTE ÁREA 250 [1.3Kg]	Ø250X60	237.20
57691	ÁREA 300 SHOWER HEAD ③ POMMEAU P/DOUCHETTE ÁREA 300 [2.1Kg]	Ø301X60	304.67
56991	ÁREA 500 SHOWER HEAD ④ POMMEAU P/DOUCHETTE ÁREA 500 [4.4Kg]	Ø500X60	658.47

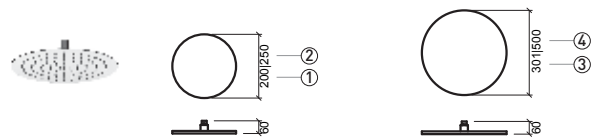

1 SQUARE COUNTERTOP/À ENCASTRER

€ CHROME

57091	COUNTERTOP SQUARE 380 SHOWER HEAD ① POMMEAU P/DOUCHETTE SQUARE 380 À ENCASTRER [4.9Kg]	380X380	997.84
57191	COUNTERTOP SQUARE 500 SHOWER HEAD ② POMMEAU P/DOUCHETTE SQUARE 500 À ENCASTRER [11.4Kg]	500X500	1180.46

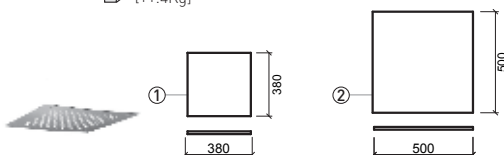

HYDRO SOLUTIONS/SOLUTIONS D'HYDRO

1 ÁREA COUNTERTOP/À ENCASTRER

€ CHROME

57291	COUNTERTOP ÁREA 380 SHOWER HEAD POMMEAU P/DOUCHETTE ÁREA 380 À ENCASTRER [3.9Kg]	①	Ø380	972.53
57391	COUNTERTOP ÁREA 500 SHOWER HEAD POMMEAU P/DOUCHETTE ÁREA 500 À ENCASTRER [9.4Kg]	②	Ø498	1180.46

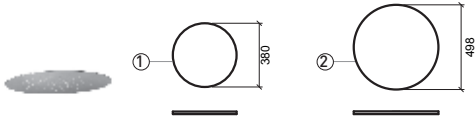

1 SHOWER HEAD ARM SQUARE PROFILE BRAS DE DOUCHE PROFILE CARRÉ

€ CHROME

5804011	100 SHOWER HEAD ARM BRAS DE DOUCHE 100	56.92
5805011	200 SHOWER HEAD ARM BRAS DE DOUCHE 200	67.20
5806011	300 SHOWER HEAD ARM BRAS DE DOUCHE 300	75.11



1 KING

€ CHROME

5659111	COUNTERTOP SHOWER HEAD POMMEAU P/DOUCHETTE À ENCASTRER [30.5Kg]	700X380	1813.67
----------------	--	---------	---------

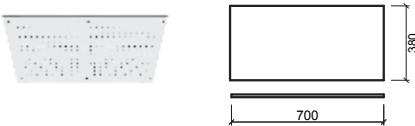

2 CONCEALED VALVE ROBINET À ENCASTRER

€ CHROME

5680011	CONCEALED VALVE 1/2 TUBE/ENJOY ROBINET À ENCASTRER 1/2 TUBE/ENJOY	62.65
----------------	---	-------



1 QUADRA

€ CHROME

58791	QUADRA 250 SHOWER HEAD POMMEAU P/DOUCHETTE QUADRA 250 [1.2Kg]	250x250x53	213.99
--------------	--	------------	--------



2 TUBE COUNTERTOP/ENCASTRER

€ CHROME

5318801	WALL MOUNTED MIXER F/BATH 125x105 MITIGEUR DE BAIN P/ENCASTRER 125x105 [4.0Kg]	105X170X60	269.86
----------------	---	------------	--------

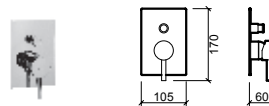

1 SHOWER HEAD ARM BRAS DE DOUCHE

€ CHROME

5800011	SHOWER HEAD ARM BRAS DE DOUCHE [0.4Kg]	①	90.91
5807011	SHOWER HEAD ARM 340 ROUND PROFILE BRAS DE DOUCHE 340 PROFILE ROUND	②	75.11
5808011	SHOWER HEAD ARM 340 SQUARE PROFILE BRAS DE DOUCHE 340 PROFILE CARRÉ	③	91.40

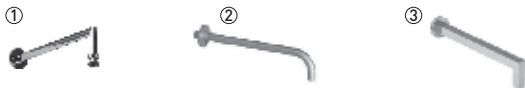

2 TUBE COUNTERTOP/ENCASTRER

€ CHROME

5316701	4 WAY WALL MOUNTED MIXER W/HAND-SHOWER AND SHOWER HEAD MITIGEUR À ENCASTRER A/DOUCHETTE ET TÊTE P/DOUCHETTE [3.9Kg]	305X75X105	305.47
----------------	--	------------	--------

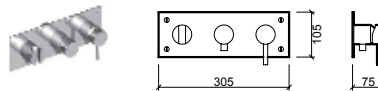

1 SHOWER HEAD ARM ROUND PROFILE BRAS DE DOUCHE PROFILE ROUND

€ CHROME

5801011	100 SHOWER HEAD ARM BRAS DE DOUCHE 100	44.11
5802011	200 SHOWER HEAD ARM BRAS DE DOUCHE 200	49.18
5803011	300 SHOWER HEAD ARM BRAS DE DOUCHE 300	56.92



2 TUBE COUNTERTOP/ENCASTRER Ø120

€ CHROME

5318701	WALL MOUNTED MIXER F/BATH W/ROUNDED MIRROR 120 MITIGEUR BAIN À ENCASTRER A/ROSACE ARRONDI 120 [4.0Kg]	① Ø120X65X149	272.95
5317801	4 WAY WALL MOUNTED MIXER F/BATH W/ROUNDED MIRROR 120 MITIGEUR BAIN À ENCASTRER A/ROSACE ARRONDI 120	② Ø120X65X170	201.03

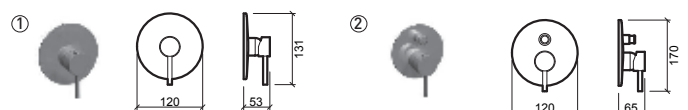

LEGEND | LÉGENDE
W. WHITE B. BLANC CR. COLOR | COULEUR - PERGAMON
[-] CHECK AVAILABILITY | SOUS RÉSERVE DE DISPONIBILITÉ

HYDRO SOLUTIONS/SOLUTIONS D'HYDRO

2 TUBE COUNTERTOP/ENCASTRER

€ CHROME

531170111C	3 WAY WALL MOUNTED TUBE MITIGEUR DE DOUCHE À ENCASTRER TUBE [0.8Kg]	①	194.36
531710111	3 WAY WALL MOUNTED TUBE W/SQUARE MIRROR MITIGEUR DE DOUCHE À ENCASTRER TUBE A/ROSACE [0.9Kg]	②	201.15
531180111C	4 WAY WALL MOUNTED TUBE MITIGEUR DE DOUCHE À ENCASTRER TUBE [1.3Kg]	③	262.65
53106111	4 WAYS CONCEALED VALVE MITIGEUR À ENCASTRER [0.8Kg]	④	109.59



3 JETS

€ CHROME

578911	WALL ROUND JET JET ARRONDI P/MUR [0.2Kg]	①	35.26
579911	WALL SQUARE JET JET CARRÉ P/MUR [0.2Kg]	②	43.48



4 DUO

€ CHROME

59691	HAND-SHOWER DOUCHETTE [0.2Kg]	Ø32X220	34.53
-------	-------------------------------------	---------	-------



4 PLAN

€ CHROME

58891	HAND-SHOWER DOUCHETTE [0.4Kg]	27X220	37.90
-------	-------------------------------------	--------	-------

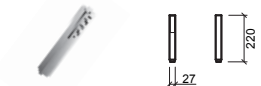

4 FACE

€ CHROME

58193	3 FUNCTIONS FACE 120 HAND-SHOWER DOUCHETTE 3 FONCTIONS FACE 120 [0.4Kg]	120X56	107.28
-------	--	--------	--------



4 EKO



€ CHROME

563910	EKO 100 HAND-SHOWER DOUCHETTE EKO 100 [0.2Kg]	①	100X239	37.96
564910	EKO 130 HAND-SHOWER DOUCHETTE EKO 130 [0.3Kg]	②	130X269	46.67

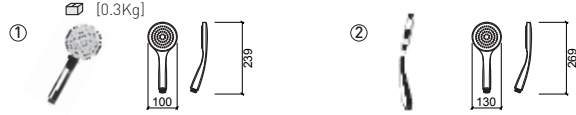

5 DECK/SUPPORT | SUPPORT

€ CHROME

5A311801	DECK F/4 WAY TUBE MIXER SUPPORT P/MITIGEUR TUBE À ENCASTRER	①	15.94
5690211	ROUNDED FIXED SUP. F/HAND-SHOWER W/MIRROR SUP. ARRONDI P/DOUCHETTE A/MIROIR	②	26.88



5 DECK/SUPPORT | SUPPORT

€ CHROME

5690111	DECK WAY OUT WATER W/MIRROR SUP. P/MITIGEUR SORTIE D'EAU A/ROSACE [0.3Kg]	①	57.24
5690011	SQUARE FIXED SUP. F/HAND-SHOWER WITHOUT MIRROR SUP. CARRÉ P/DOUCHETTE SANS ROSACE [0.1Kg]	②	7.36



5 DECK/SUPPORT | SUPPORT

€ CHROME

5690411	DECK WAY OUT WATER W/ROUND SUP. SORTIE D'EAU A/SUP. ARRONDI	①	63.75
5690311	DECK WAY OUT WATER W/SQUARE SUP. SORTIE D'EAU A/SUP. CARRÉ	②	84.35

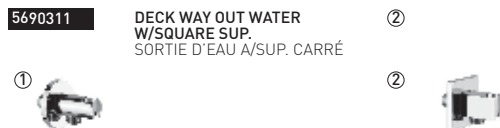

e-Ceramica

Contact us for wholesale prices or cooperation:

Zoran Milić

E-mail: zm@e-ceramica.com

Mobile : + 386 41 684 696

Telephone : + 386 2 780 54 90

Fax : + 386 2 779 76 61

Merilly d.o.o. ; Vodnikova ulica 2 ; Si 2250 Ptuj ; Slovenia

Web :

• Americas

[Sanitary ware in Argentina](#)
[Sanitary ware in Bahamas](#)
[Sanitary ware in Bolivia](#)
[Sanitary ware in Canada](#)
[Sanitary ware in Chile](#)
[Sanitary ware in Colombia](#)
[Sanitary ware in Costa Rica](#)
[Sanitary ware in Cuba](#)
[Sanitary ware in Ecuador](#)
[Sanitary ware in El Salvador](#)
[Sanitary ware in Guatemala](#)
[Sanitary ware in Honduras](#)
[Sanitary ware in Jamaica](#)
[Sanitary ware in México](#)
[Sanitary ware in Nicaragua](#)
[Sanitary ware in Panamá](#)
[Sanitary ware in Paraguay](#)
[Sanitary ware in Perú](#)
[Sanitary ware in Re. Dominicana](#)
[Sanitary ware in Trin. & Tobago](#)
[Sanitary ware in Uruguay](#)
[Sanitary ware in USA](#)
[Sanitary ware in Venezuela](#)

• Europe

[Sanitary ware in BiH](#)
[Sanitary ware in Crna Gora](#)
[Sanitary ware in España](#)
[Sanitary ware in France](#)
[Sanitary ware in Germany](#)
[Sanitary ware in Hrvatska](#)
[Sanitary ware in Ireland](#)
[Sanitary ware in Kosove](#)
[Sanitary ware in Liechtenstein](#)
[Sanitary ware in Magyarország](#)
[Sanitary ware in Македонија](#)
[Sanitary ware in Magedoni](#)
[Sanitary ware in Malta](#)
[Sanitary ware in Österreich](#)
[Sanitary ware in Russia](#)
[Sanitary ware in Schweiz](#)
[Sanitary ware in Suisse](#)
[Sanitary ware in Shqiperi](#)

[Sanitary ware in Slovenija](#)

[Sanitary ware in Србија](#)
[Sanitary ware in United Kingdom](#)

• Asia

[Sanitary ware in India](#)
[Sanitary ware in Pakistan](#)
[Sanitary ware in Philippines](#)
[Sanitary ware in Singapore](#)
[Sanitary ware in Turkiye](#)

• Africa & Australia

[Sanitary ware in Australia](#)
[Sanitary ware in Cameroon](#)
[Sanitary ware in Ghana](#)
[Ceramics in Guinea Ecuatorial](#)
[Sanitary ware in Swaziland](#)
[Sanitary ware in New Zealand](#)
[Sanitary ware in Nigeria](#)